

1591D Enclosure

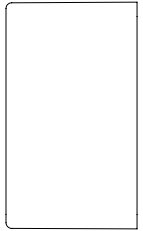

SIDE VIEW OF BOX

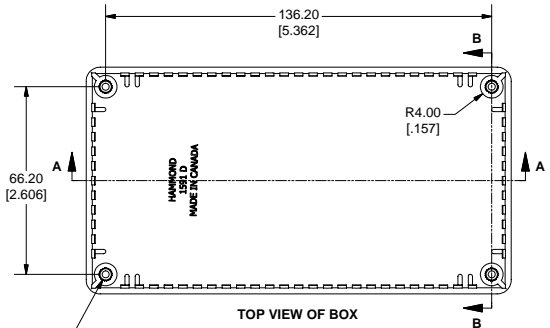

TOP VIEW OF BOX

M3 X 0.5 - 6H x 5.75

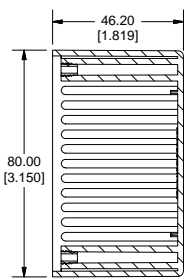

SECTION B-B

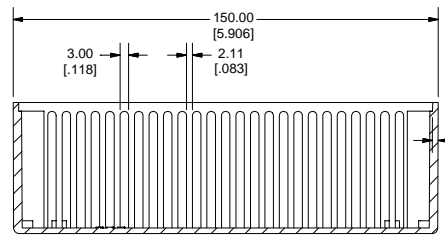

SECTION A-A

AVERAGE WALL THICKNESS
2.00 [0.079]

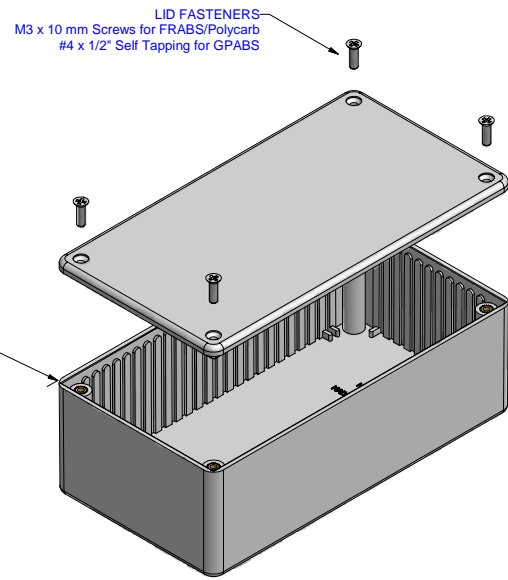

EXPLODED VIEW OF ENCLOSURE

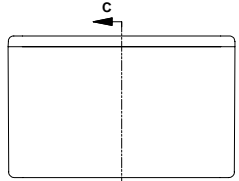

END VIEW OF ASSEMBLY

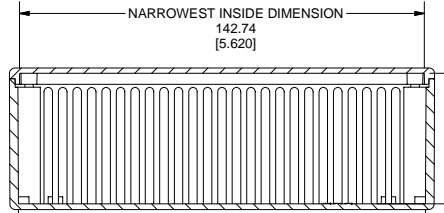

SECTION C-C

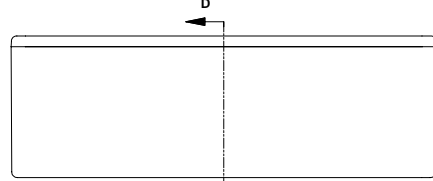

SIDE VIEW OF ASSEMBLY

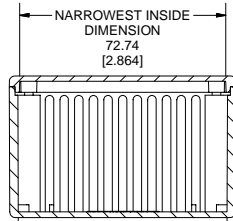

SECTION D-D

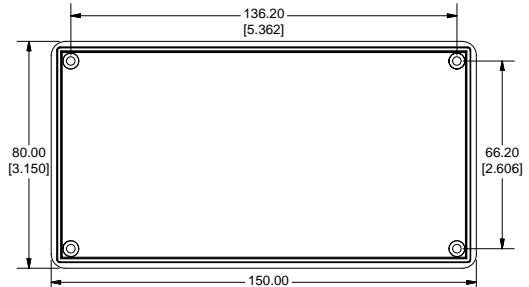

BOTTOM ON LID

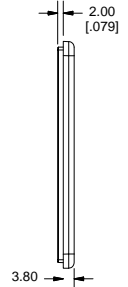

SIDE OF LID

Note:
Enclosures can be Factory Modified (Milling, Drilling, Printing etc.)
Solid models of this enclosure available in STEP or IGES Format.
Contact Factory mjm@hammondmfg.com



PART NUMBERS		
1591D Enclosures		
Material	Colour	Part Number
FR ABS	Black	1591DBK
	Grey	1591DGY
UL94 - V0	Black Shielded (Conductive Paint)	1591RDBK
	Black	1591DSBK
GP ABS	Grey	1591DSGY
	Ice Blue	1591DTBU
Translucent Polycarbonate	IR Red	1591DTRD
	Crystal Clear	1591DTCL
Accessories		
Description	Part Number	
Universal Application	PC Board Card Adapters	See Accessories Section
	Flange Kits	See Accessories Section
	Clear Lids - clear, flame retardant polycarbonate - Lid ONLY	1591DC
FR ABS & Polycarbonate	Replacement Screws, Flat head Phillips, Nickel Plated Pkg of 100	1591MS100 (Black) 1591TS100
	Self Tapping Pkg of 100	1591TS100BK (Black)
Required Torque on Fasteners (no lubrication)		
M3 - 0.5 x 10mm Screws		30-40 cN*m
#4 x 0.5 Screws		30-40 cN*m